

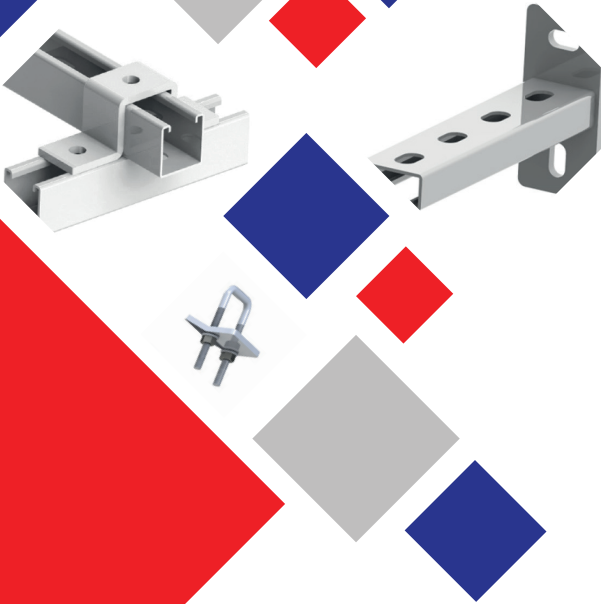

Clim[®]



SUPPORT & FIXING



CANTILEVER ARMS

	Code	<input type="checkbox"/>	<input type="checkbox"/>	<input type="checkbox"/>
CPS 41x21	486443	300 mm	160 DaN	2 mm
CPS 41x41	486463	300 mm	500 DaN	2 mm
CPS 41x41	486464	450 mm	310 DaN	2 mm
CPS 41x41	486466	600 mm	200 DaN	2 mm
CPS 41x41	486468	750 mm	180 DaN	2 mm
CPS 41x41	486470	1000 mm	100 DaN	2 mm

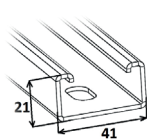

CPS
41x21

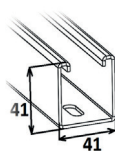
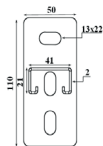

CPS
41x41

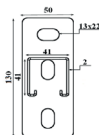

LOCKING PLATE

	Code	<input type="checkbox"/>
P-VER-M8	487401	M8
P-VER-M10	487402	M10

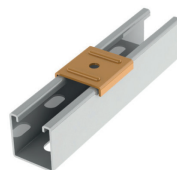
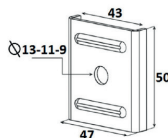

WASHERS

	Code	<input type="checkbox"/>
CWA-M8x40x3	472108	M8 x 40mm x 3 mm
CWA-M10x40x3	472110	M10 x 40mm x 3 mm



CHANNEL NUTS

	Code	
CCN-M6	472006	Fileté M6
CCN-M8	472008	Fileté M8
CCN-M10	472010	Fileté M10



	Code	
CCN-LS-M6	472046	Fileté M6
CCN-LS-M8	472048	Fileté M8
CCN-LS-M10	472050	Fileté M10



DOUBLE CHANNEL NUT

	Code	
VIS-DBL M8x30	472083	M8 x 30 mm
VIS-DBL M8x40	472084	M8 x 40 mm
VIS-DBL M10x30	472103	M10 x 30 mm
VIS-DBL M10x40	472104	M10 x 40 mm

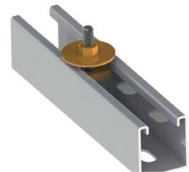

CHANNEL BASE

- Provided with a built-in connecting plate (not shown on the pictures)

	Code
PRV	487101
PRH	487102
L-PRV	487103

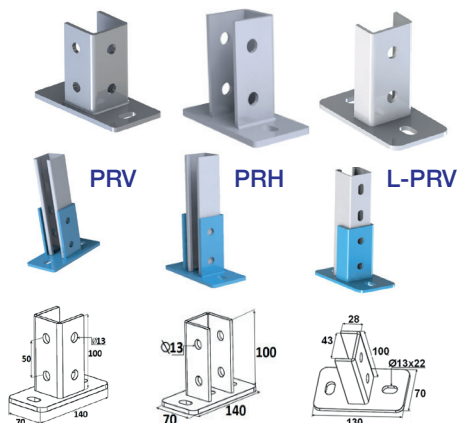

FLAT FITTINGS

	Code
P-ASB-4T	487424
P-ASB-L-3T	487426
P-ASB-T-4T	487427

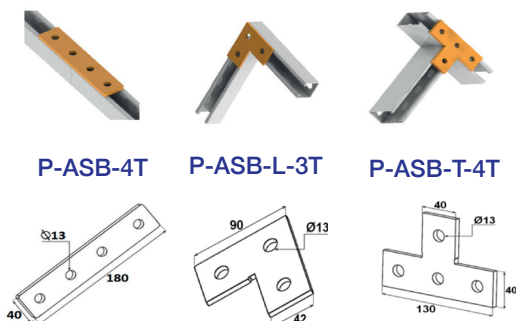

COUPLING SLEEVE

	Code
RAC 41x41	487432

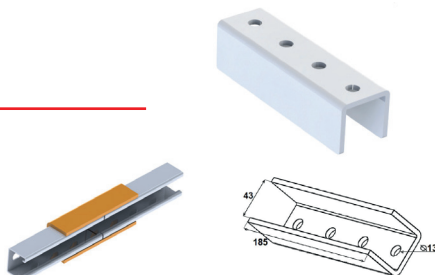

ANGLE BRACKET

	Code
EQ-90-2T	487428
EQ-90-4T	487430
EQ-3F	487449
EQ-G-4T	487431
EQ-45-2T	487460
EQ-45-4T	487496

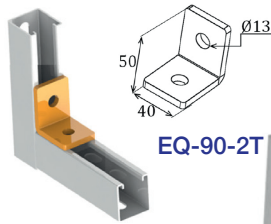

EQ-90-2T

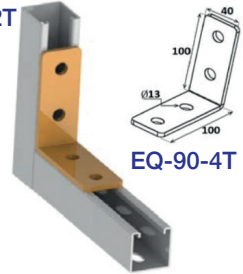

EQ-90-4T

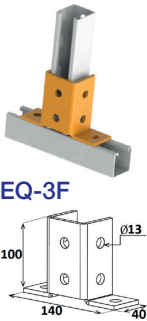

EQ-3F

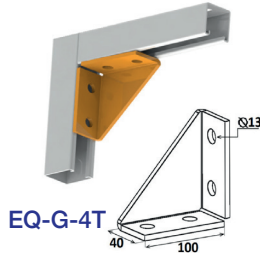

EQ-G-4T



EQ-45-2T

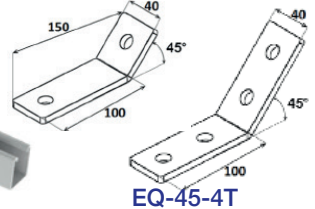

EQ-45-4T

OMÉGAS

	Code
OM 41x21	487440
OM 41x41	487441

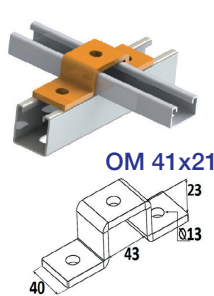

OM 41x21

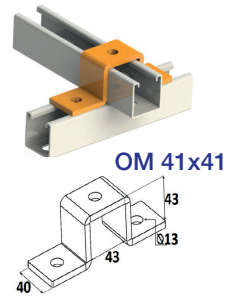

OM 41x41

STEEL BEAM CLAMPS

	Code
ETR M8	487393
ETR M10	487394

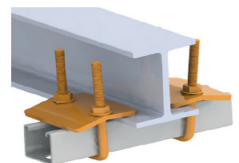

BEAM CLAMPS

	Code	Info.	
CTKN8-M8	468108	Fileté M8	120
CTKN10-M10	468110	Fileté M10	250
CTK12-M12	468112	Fileté M12	350
CTKN8-9	468109	Dia. 9mm	120
CTKN10-11	468111	Dia. 11mm	250
CTK12-13	468113	Dia. 13mm	350

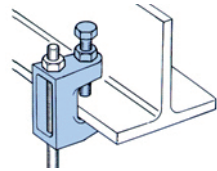

DOUBLE THREAD SCREW

	Code	
GDF-M8	471920	M8 x 10mm x 50mm



RECTANGULAR PLATE

	Code	
P-REC-M8	487410	M8
P-REC-M10	487411	M10



THREADED RODS

	Code	
CTR-M6 x 1m	471006	M6 x 1 m
CTR-M8 x 1m	471008	M8 x 1 m
CTR-M10 x 1m	471010	M10 x 1 m



THREADED RODS CONNECTORS

	Code	
CRC-HEXA-M8	471102	M8 x 30mm
CRC-HEXA-M10	471103	M10 x 30mm
CRC-M6	471106	M6 x 20mm
CRC-M8	471108	M8 x 30mm
CRC-M10	471110	M10 x 30mm



CRC-HEXA

CRC

BRASS AND STEEL ANCHORS

	Code	
CBA-M6	471506	M6 x 25mm
CBA-M8	471508	M8 x 30mm
CBA-M10	471510	M10 x 40mm
CSA-M6	sur demande	M6
CSA-M8	sur demande	M8
CSA-M10	sur demande	M10



WASHERS, NUTS, SREWS AND BOLT

	Code	
CSW-M8	471308	8,4 x 16 x 1,6 mm
CSW-M10	471310	10,5 x 20 x 2,0 mm
CLW-M6-L	471406	6,4 x 18 x 1,6 mm
CLW-M8-L	471408	8,4 x 24 x 2,0 mm
CLW-M10-L	471410	10,5 x 30 x 2,5 mm
CAR-M6	471426	6,4 x 25 x 1,5 mm
CAR-M8	471428	8,4 x 30 x 1,5 mm
CHN-M6	471206	M6
CHN-M8	471208	M8
CHN-M10	471210	M10
CTH-M8x20	471622	M8 x 20 mm
CTH-M8x25	471623	M8 x 25 mm
CTH-M8x30	471624	M8 x 30 mm
CTH-M10x25	471633	M10 x 25 mm
CTH-M10x30	471634	M10 x 30 mm
BOULONS-M8x20	471722	M8 x 20 mm
BOULONS-M8x25	471723	M8 x 25 mm
BOULONS-M8x30	471724	M8 x 30 mm
BOULONS-M10x25	471733	M10 x 25 mm
BOULONS-M10x30	471734	M10 x 30 mm



PRODUCTS ON DEMAND



VIS-P-VER

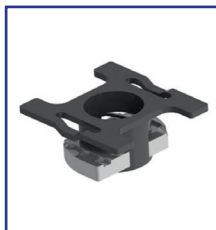

CHN AUTO



L-PRH



PRC



PRV-DBL

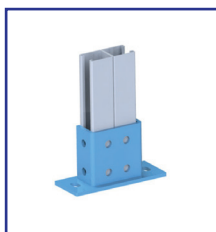

PRH-DBL

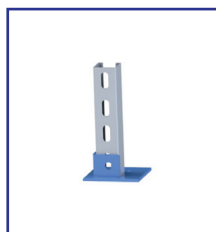

SOCLE-EXT



SOCLE-INT



RENFORT



JAMBE

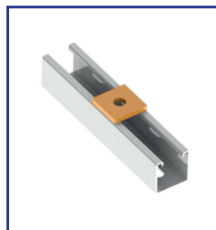

P-ASB-1T

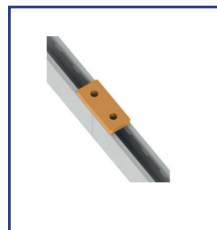

P-ASB-2T



P-ASB-3T



EQ-90-3T

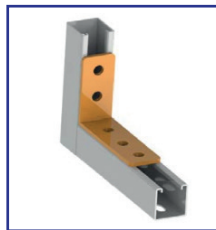

EQ-90-5T

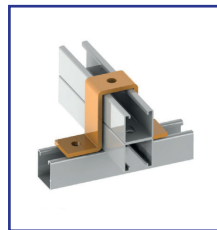

OM-DBL-41x41

PRODUCTS ON DEMAND



EQ-DBL-4T

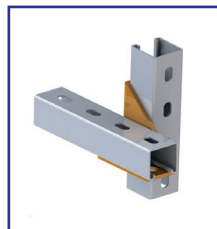

EQ-X-4T



EQ-T-4T



EQ-30-2T



EQ-60-2T

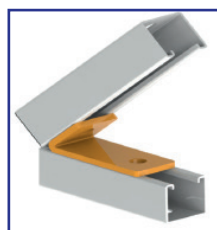

EQ-150-2T



EQ-135-2T



EQ-120-2T

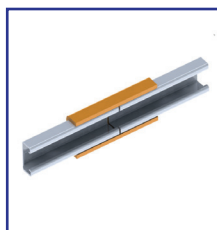

RAC 41x21

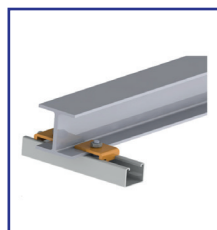

CRAPAUD

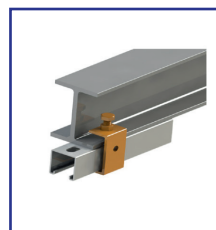

CRAPAUD XL

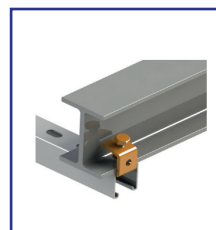

CRAPAUD U



90, Route de Beaumont
1380 Lasne - Belgium
T. +32 2 654 12 40
clim@climatech.be
www.climatech.be

2022.03.08

 **Climatech**
INTERNATIONAL